

DW60

Wheel Dumpers



**WACKER
NEUSON**
all it takes!



The power package

The wheel dumper has everything a powerful workhorse needs: hydrostatic all-wheel drive with ECO mode, 2 skip types, 6,000 kg payload and the strongest engine versions in its class. The modern safety cab (optional) turns it into a dumper for every season. All factory-installed, as only Wacker Neuson knows how.

- Performance enhancements: DW60 power version with engine output of 86 kW
- 2 types of skips: Front tip or swivel tip skip
- Supreme off-road capability thanks to a articulated pendulum joint angle of 29 degrees.
- Travel speeds of up to 25 km/h for high speed transport jobs
- Available ex factory with a cabin

DW60 Technical specifications

	Front tip skip	Swivel tip skip
Operating data		
Payload kg	6,000	6,000
Shipping weight ROPS kg	4,532	4,919
Shipping weight cabin kg	4,732	5,119
Operating weight ROPS kg	4,614	5,001
Operating weight cabin kg	4,814	5,201
Skip capacity struck l	2,650	2,350
Skip capacity heaped l	3,500	3,200
Skip capacity water volume l	1,900	1,660
Engine / Motor Level 3a/Tier 3 (not for Western Europe)		
Engine / Motor manufacturer	Perkins	Perkins
Engine / Motor type	1104D	1104D
Engine / Motor	water-cooled 4-cylinder turbo-diesel	water-cooled 4-cylinder turbo-diesel
Engine performance according to ISO 3046/1 kW	62.5	62.5
Displacement cm ³	4,399	4,399
Engine RPM rpm	2200	2200
Emissions	Level 3a/Tier 3	Level 3a/Tier 3
Traction drive	4WD, hydrostatic	4WD, hydrostatic
Travel speed km/h	25	25
Articulation angle °	29	29
Pendulum angle °	11	11
Turning radius mm	6,149	5,998
Gradeability %	50	50
Tires	400/55R22.5	400/55R22.5
L x W x H mm	4577 x 2230 x 3108	4934 x 2230 x 3108
Steering pump	Axial piston pump	Axial piston pump
Flow rate l/min	152	152
Operating pressure bar	450	450
Duty pump	Gear pump	Gear pump
Flow rate l/min	68	68
Operating pressure bar	240	235
Tank capacity l	83	83

Operating data

Engine / Motor Level 3b/Tier 4 final (for Western Europe)

Engine / Motor manufacturer	Perkins	Perkins
Engine / Motor type	854F	854F

Engine / Motor	water-cooled 4-cylinder turbo-diesel	water-cooled 4-cylinder turbo-diesel
Engine performance kW	55	55
Displacement cm ³	3,400	3,400
Engine RPM rpm	2500	2500
Emissions	Level 3b/Tier 4 final	Level 3b/Tier 4 final
Traction drive	4WD, hydrostatic	4WD, hydrostatic
Travel speed km/h	25	25

DW60 Dimensions

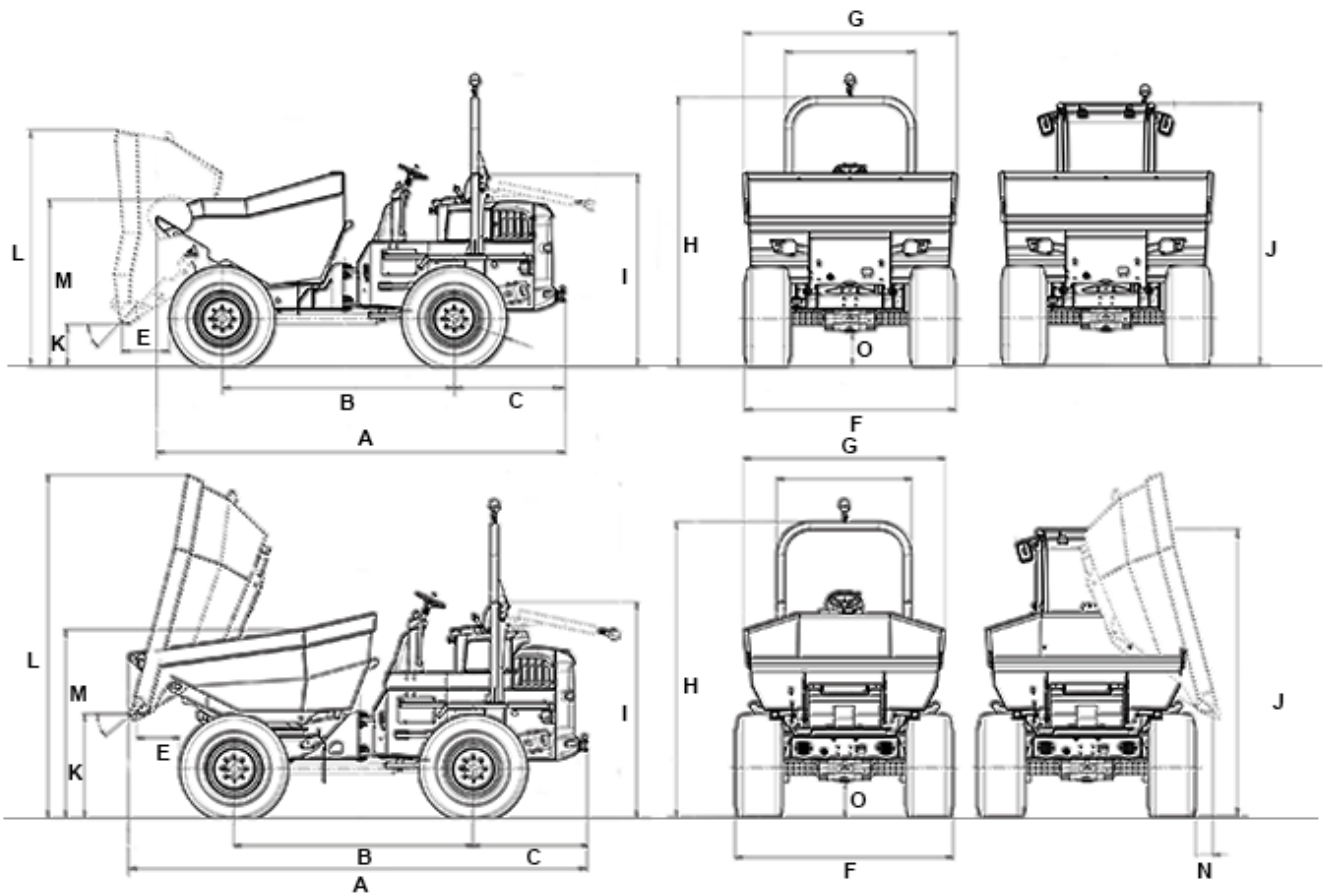

		front tip skip	swivel tip skip	power swivel tip skip
A	Overall length	4,577 mm	4,934 mm	4,768 mm
B	Wheelbase	2,485 mm	2,485 mm	2,485 mm
C	Rear overhang	1,192 mm	1,192 mm	1,192 mm
E	Dumping distance	609 mm	502 mm	488 mm
F	Width	2,230 mm	2,230 mm	2,230 mm
G	Skip width	2,329 mm	2,091 mm	2,091 mm
H	Height ROPS	3,108 mm	3,108 mm	3,108 mm
I	Height ROPS tilted	2,186 mm	2,186 mm	2,186 mm
J	Height Cabine	2,998 mm	2,993 mm	
K	Dump height max.	458 mm	1,082 mm	1,174 mm
L	Skip height tilted	2,488 mm	3,524 mm	3,524 mm
M	Skip height	1,813 mm	1,905 mm	1,905 mm
N	Dumping distance lateral		115 mm	101 mm
O	Ground clearance	369 mm	369 mm	369 mm
--	Dump angle	43 °	48 °	48 °

Please note: that product availability can vary from country to country. It is possible that information / products may not be available in your country. More detailed information on engine power can be found in the operator's manual; the stated power may vary due to specific operating conditions. Subject to alterations and errors excepted. Applicable also to illustrations.
Copyright © 2019 Wacker Neuson SE.